

Set 1

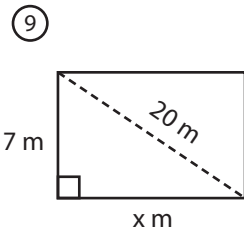

Set 2

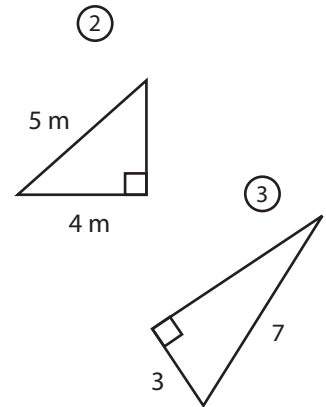

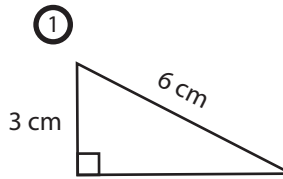
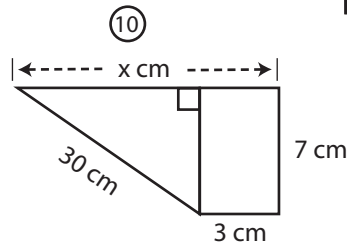
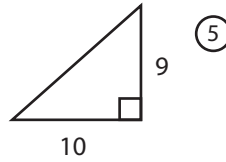
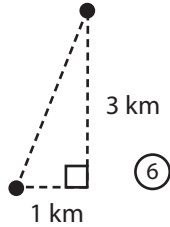
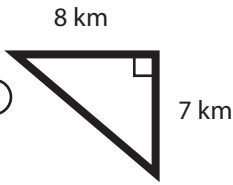
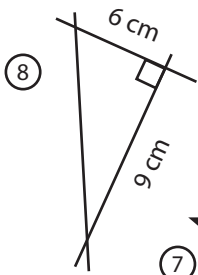
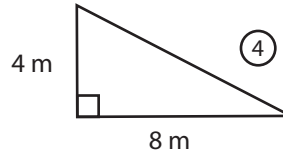
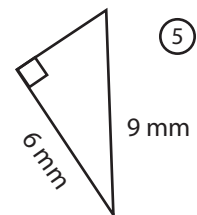
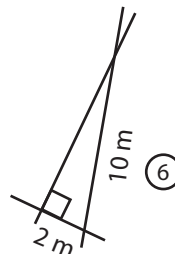
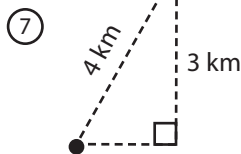
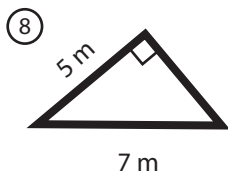
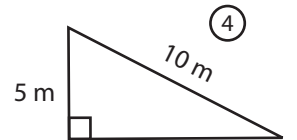

Answers (to 2 dp) : Set 1

1. 5 cm
2. 6.71 cm
3. 8.60 m
4. 8.94 m
5. 13.45
6. 3.16 km
7. 10.63 km
8. 10.82 cm
9. 12.04 m
10. 36.06 m

Answers (to 2 dp) : Set 2

1. 5.20 cm
2. 3 m
3. 6.32
4. 8.66 m
5. 6.71 mm
6. 9.80 m
7. 2.65 km
8. 4.90 m
9. 18.73 m
10. $29.17 \text{ cm} + 3 \text{ cm} = 32.17 \text{ cm}$